

414262

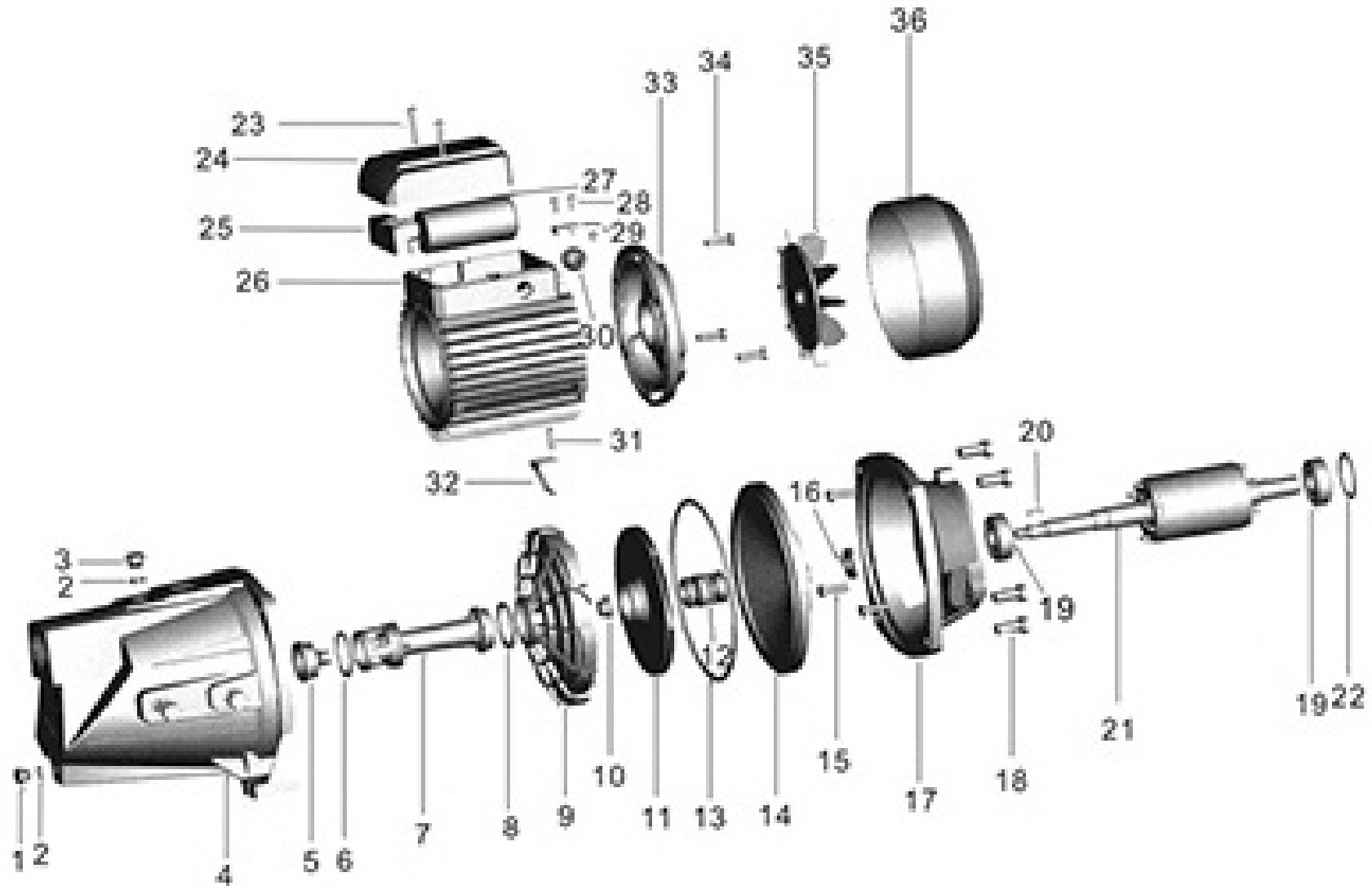

	description	popis	qty/ks	order No. / obj. číslo dílu	set order No. / obj. číslo sady
1	discharge plug	zátká vypouštěcího otvoru			
2	O - ring	O - kroužek			
3	charge plug	zátká zalévacího otvoru			
4	pump casing	tělo čerpadla			
5	nozzle	tryska			
6	O - ring	O - kroužek			
7	venturi pipe	venturiho trubice			
8	O - ring	O - kroužek			
9	diffuser	difuzér			
10	nut	matice			
11	impeller	oběžné kolo			
12	mechanical seal	mechanické těsnění			
13	O - ring	O - kroužek			
14	pump casing cover	kryt tělesa čerpadla			
15	bolt	šroub			
16	drops guard	těsnění			
17	pump support	kryt čerpadla			
18	bolt	šroub			
19	bearing	ložisko			
20	key	klínek			
21	rotor	rotor			
22	split ring	dělicí kroužek			
23	bolt	šroub			
24	terminal cover	kryt propojovací skříňky			
25	terminal board	svorkovnice			
26	casing with wound stator	stator se skříňkou			
27	capacitor	kondenzátor			
28	screw	šroub			
29	cable presser	kabelová svorka			
30	fairlead	kabelová průchodka			
31	stand pin	čep			
32	stand	patka			
33	driving cap	kryt statoru			
34	bolt	šroub			
35	fan	ventilátor			
36	fan cover	kryt ventilátoru			